

## FYREYE MKII ADDRESSABLE INPUT/OUTPUT MODULE WITH ISOLATOR INSTALLATION GUIDE

### General

The Fyreye MkII Addressable Input/Output Module is supplied with a backbox for surface mounting.

NOTE: The Input/Output Module is designed for indoor use only.

This product is loop powered and a maximum of 60 devices are allowed on any Zeta detection loop.

Model No: ZAIO-MI          Fyreye MkII Addressable Input/Output Module With Isolator

### Surface Mounting

1. Mount the backbox as required and install all cables for termination.
2. Set the address of the unit as shown on page 3.
3. Terminate all cables.
4. Gently push the completed assembly towards the back box until the mounting holes are aligned and secure with the two mounting screws provided. DO NOT OVERTIGHTEN.

### Isolator Module

The ZAIO-MI Module is fitted with a bi-directional short-circuit isolator and will be unaffected by loop short-circuits on either loop input or output.

### LED Indications

Status	LED Indication
Switch closed	Illuminated red when monitored field contact is activated
Relay on	Illuminated red when relay is energized
Fault	Illuminated yellow when the input is open or short circuit
Polling	Flashed green when the device is polled by control panel
Isolating	Illuminated yellow when the loop is short or wrong connection circuit

## Wiring details

All wiring terminals will accept solid or stranded cables up to 2.5mm<sup>2</sup>

## Interface to 3rd Party Panel

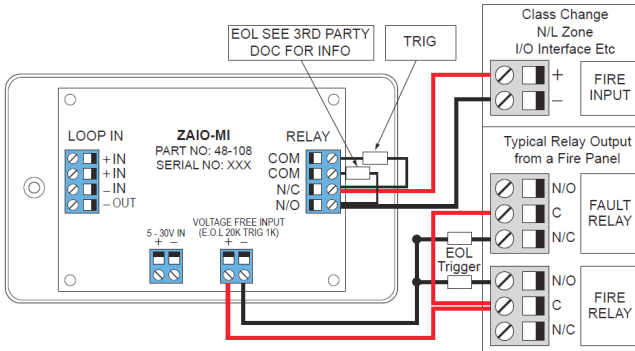

## Door Magnet

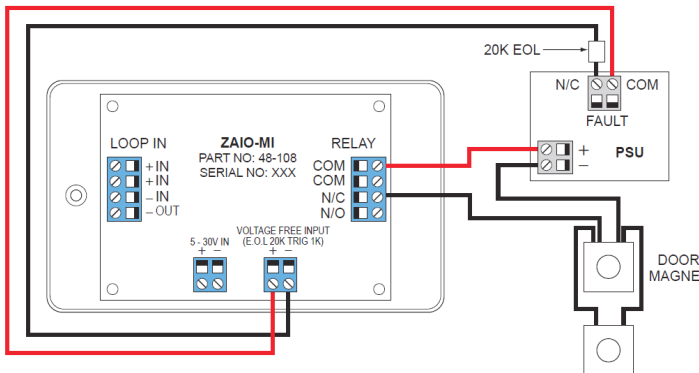

## Normally Open Contact

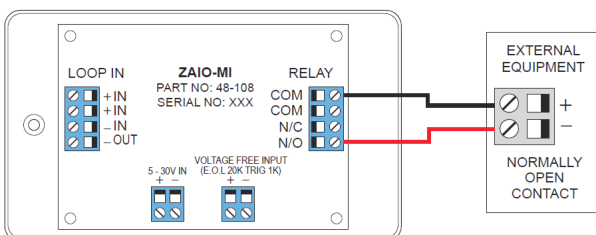

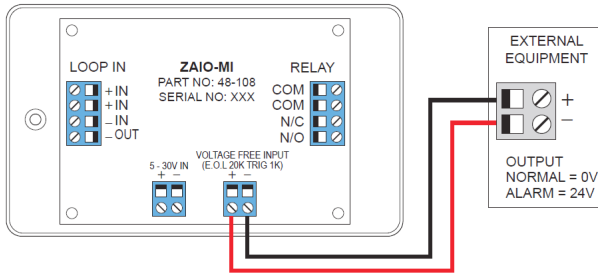

## Technical Specification

Model	ZAIO-MI
Part Number	48-108
Operating Voltage	17-28V DC
Quiescent Current @ 24V	1.0mA
Switch Input Closed (LED OFF)	1.25mA
Relay Operated (LED ON)	2.0mA (Max 2 LEDs on)
Relay Rating	SELV @ 1A
Isolating Current	7.3mA
Input End Of Line	20k
Alarm Triggering Resistor	1k
Operating Temperature	-10°C to +55°C
Max Humidity	95% RH Non Condensing
IP rating	IP21C
Size (mm)	150 x 90 x 45
Weight	220g

For information on the short circuit isolator operation see document GLT-224-6-9 available from your distributor.

## Address Setting

The address of the Input/Output Module is set using the eight segments of the DIL switch. Each segment of the switch must be set to “0”(ON) or “1”(OFF), using a small screwdriver or similar tool. A complete list of address settings is shown overleaf. The maximum address is 250.

ADDRESS	SW1	SW2	SW3	SW4	SW5	SW6	SW7	SW8
0								
1	OFF	ON	ON	ON	ON	ON	ON	ON
2	ON	OFF	ON	ON	ON	ON	ON	ON
3	OFF	OFF	ON	ON	ON	ON	ON	ON
4	ON	ON	OFF	ON	ON	ON	ON	ON
5	OFF	ON	OFF	ON	ON	ON	ON	ON
6	ON	ON	OFF	ON	ON	ON	ON	ON
7	OFF	OFF	OFF	ON	ON	ON	ON	ON
8	ON	ON	ON	OFF	ON	ON	ON	ON
9	OFF	ON	ON	OFF	ON	ON	ON	ON
10	ON	OFF	ON	OFF	ON	ON	ON	ON
11	OFF	OFF	ON	OFF	ON	ON	ON	ON
12	ON	ON	OFF	OFF	ON	ON	ON	ON
13	OFF	ON	OFF	OFF	ON	ON	ON	ON
14	ON	OFF	OFF	OFF	ON	ON	ON	ON
15	OFF	OFF	OFF	OFF	ON	ON	ON	ON
16	ON	ON	ON	ON	OFF	ON	ON	ON
17	OFF	ON	ON	ON	OFF	ON	ON	ON
18	ON	OFF	ON	ON	OFF	ON	ON	ON
19	OFF	OFF	ON	ON	OFF	ON	ON	ON
20	ON	ON	OFF	ON	OFF	ON	ON	ON
21	OFF	ON	OFF	ON	OFF	ON	ON	ON
22	ON	OFF	OFF	ON	OFF	ON	ON	ON
23	OFF	OFF	OFF	ON	OFF	ON	ON	ON
24	ON	ON	ON	OFF	OFF	ON	ON	ON
25	OFF	ON	ON	OFF	OFF	ON	ON	ON
26	ON	OFF	ON	OFF	OFF	ON	ON	ON
27	OFF	OFF	ON	OFF	OFF	ON	ON	ON
28	ON	ON	OFF	OFF	OFF	ON	ON	ON
29	OFF	ON	OFF	OFF	OFF	ON	ON	ON
30	ON	OFF	OFF	OFF	OFF	ON	ON	ON
31	OFF	OFF	OFF	OFF	OFF	ON	ON	ON
32	ON	ON	ON	ON	ON	OFF	ON	ON
33	OFF	ON	ON	ON	ON	OFF	ON	ON
34	ON	OFF	ON	ON	ON	OFF	ON	ON
35	OFF	OFF	ON	ON	ON	OFF	ON	ON
36	ON	ON	OFF	ON	ON	OFF	ON	ON
37	OFF	ON	OFF	ON	ON	OFF	ON	ON
38	ON	OFF	OFF	ON	ON	OFF	ON	ON
39	OFF	OFF	OFF	ON	ON	OFF	ON	ON
40	ON	ON	ON	OFF	ON	OFF	ON	ON
41	OFF	ON	ON	OFF	ON	OFF	ON	ON
42	ON	OFF	ON	OFF	ON	OFF	ON	ON
43	OFF	OFF	ON	OFF	ON	OFF	ON	ON
44	ON	ON	OFF	OFF	ON	OFF	ON	ON
45	OFF	ON	OFF	OFF	ON	OFF	ON	ON
46	ON	OFF	OFF	OFF	ON	OFF	ON	ON
47	OFF	OFF	OFF	OFF	ON	OFF	ON	ON
48	ON	ON	ON	ON	OFF	OFF	ON	ON
49	OFF	ON	ON	ON	OFF	OFF	ON	ON
50	ON	OFF	ON	ON	OFF	OFF	ON	ON
51	OFF	OFF	ON	ON	OFF	OFF	ON	ON
52	ON	ON	OFF	ON	OFF	OFF	ON	ON
53	OFF	ON	OFF	ON	OFF	OFF	ON	ON
54	ON	OFF	OFF	ON	OFF	OFF	ON	ON
55	OFF	OFF	OFF	ON	OFF	OFF	ON	ON
56	ON	ON	ON	OFF	OFF	OFF	ON	ON
57	OFF	ON	ON	OFF	OFF	OFF	ON	ON
58	ON	OFF	ON	OFF	OFF	OFF	ON	ON
59	OFF	OFF	ON	OFF	OFF	OFF	ON	ON
60	ON	ON	OFF	OFF	OFF	OFF	ON	ON
61	OFF	ON	OFF	OFF	OFF	OFF	ON	ON
62	ON	OFF	OFF	OFF	OFF	OFF	ON	ON
63	OFF	OFF	OFF	OFF	OFF	OFF	ON	ON

ADDRESS	SW1	SW2	SW3	SW4	SW5	SW6	SW7	SW8		
64	ON	ON	ON	ON	ON	ON	ON	ON		
65	OFF	ON	ON	ON	ON	ON	OFF	ON		
66	ON	OFF	ON	ON	ON	ON	OFF	ON		
67	OFF	OFF	ON	ON	ON	ON	OFF	ON		
68	ON	ON	OFF	ON	ON	ON	ON	OFF	ON	
69	OFF	ON	OFF	ON	ON	ON	ON	OFF	ON	
70	ON	ON	OFF	OFF	ON	ON	ON	ON	OFF	ON
71	OFF	OFF	OFF	ON	ON	ON	ON	OFF	ON	
72	ON	ON	ON	OFF	ON	ON	ON	OFF	ON	
73	OFF	ON	ON	OFF	ON	ON	ON	OFF	ON	
74	ON	OFF	ON	OFF	ON	ON	ON	OFF	ON	
75	OFF	OFF	ON	OFF	ON	ON	ON	OFF	ON	
76	ON	ON	OFF	OFF	ON	ON	ON	OFF	ON	
77	OFF	ON	OFF	OFF	ON	ON	ON	OFF	ON	
78	ON	ON	OFF	OFF	OFF	ON	ON	OFF	ON	
79	OFF	OFF	OFF	OFF	ON	ON	ON	OFF	ON	
80	ON	ON	ON	ON	OFF	ON	ON	OFF	ON	
81	OFF	ON	ON	ON	OFF	ON	ON	OFF	ON	
82	ON	OFF	ON	ON	OFF	ON	ON	OFF	ON	
83	OFF	OFF	ON	ON	OFF	ON	ON	OFF	ON	
84	ON	ON	OFF	ON	OFF	ON	ON	OFF	ON	
85	OFF	ON	OFF	ON	OFF	ON	ON	OFF	ON	
86	ON	OFF	OFF	ON	OFF	ON	ON	OFF	ON	
87	OFF	OFF	OFF	ON	OFF	ON	ON	OFF	ON	
88	ON	ON	ON	OFF	OFF	ON	ON	OFF	ON	
89	OFF	ON	ON	OFF	OFF	ON	ON	OFF	ON	
90	ON	OFF	ON	OFF	OFF	ON	ON	OFF	ON	
91	OFF	OFF	ON	OFF	OFF	ON	ON	OFF	ON	
92	ON	ON	OFF	OFF	OFF	ON	ON	OFF	ON	
93	OFF	ON	OFF	OFF	OFF	ON	ON	OFF	ON	
94	ON	OFF	OFF	OFF	OFF	ON	ON	OFF	ON	
95	OFF	OFF	OFF	OFF	OFF	ON	ON	OFF	ON	
96	ON	ON	ON	ON	ON	ON	OFF	OFF	ON	
97	OFF	ON	ON	ON	ON	ON	OFF	OFF	ON	
98	ON	OFF	ON	ON	ON	ON	OFF	OFF	ON	
99	OFF	OFF	ON	ON	ON	ON	OFF	OFF	ON	
100	ON	ON	OFF	ON	ON	ON	OFF	OFF	ON	
101	OFF	ON	OFF	ON	ON	ON	OFF	OFF	ON	
102	ON	OFF	OFF	ON	ON	ON	OFF	OFF	ON	
103	OFF	OFF	OFF	ON	ON	ON	OFF	OFF	ON	
104	ON	ON	ON	ON	OFF	ON	ON	OFF	OFF	ON
105	OFF	ON	ON	OFF	ON	ON	OFF	OFF	ON	
106	ON	OFF	ON	OFF	ON	ON	OFF	OFF	ON	
107	OFF	OFF	ON	OFF	ON	ON	OFF	OFF	ON	
108	ON	ON	OFF	OFF	ON	ON	OFF	OFF	ON	
109	OFF	ON	OFF	OFF	ON	ON	OFF	OFF	ON	
110	ON	OFF	OFF	OFF	ON	ON	OFF	OFF	ON	
111	OFF	OFF	OFF	OFF	ON	ON	OFF	OFF	ON	
112	ON	ON	ON	ON	ON	OFF	OFF	OFF	ON	
113	OFF	ON	ON	ON	ON	OFF	OFF	OFF	ON	
114	ON	OFF	ON	ON	ON	OFF	OFF	OFF	ON	
115	OFF	OFF	ON	ON	ON	OFF	OFF	OFF	ON	
116	ON	ON	OFF	ON	ON	OFF	OFF	OFF	ON	
117	OFF	ON	OFF	ON	ON	OFF	OFF	OFF	ON	
118	ON	OFF	OFF	ON	ON	OFF	OFF	OFF	ON	
119	OFF	OFF	OFF	ON	ON	OFF	OFF	OFF	ON	
120	ON	ON	ON	OFF	OFF	OFF	OFF	OFF	ON	
121	OFF	ON	ON	OFF	OFF	OFF	OFF	OFF	ON	
122	ON	OFF	ON	ON	OFF	OFF	OFF	OFF	ON	
123	OFF	OFF	ON	OFF	OFF	OFF	OFF	OFF	ON	
124	ON	ON	OFF	OFF	OFF	OFF	OFF	OFF	ON	
125	OFF	ON	OFF	OFF	OFF	OFF	OFF	OFF	ON	
126	ON	OFF	OFF	OFF	OFF	OFF	OFF	OFF	ON	
127	OFF	OFF	OFF	OFF	OFF	OFF	OFF	OFF	ON	

FYREYE MKII ADDRESSABLE INPUT/OUTPUT MODULE WITH ISOLATOR - INSTALLATION GUIDE

ADDRESS	SW1	SW2	SW3	SW4	SW5	SW6	SW7	SW8
128	ON	ON	ON	ON	ON	ON	ON	OFF
129	OFF	ON	ON	ON	ON	ON	ON	OFF
130	ON	OFF	ON	ON	ON	ON	ON	OFF
131	OFF	OFF	ON	ON	ON	ON	ON	OFF
132	ON	ON	OFF	ON	ON	ON	ON	OFF
133	OFF	ON	OFF	ON	ON	ON	ON	OFF
134	ON	ON	OFF	ON	ON	ON	ON	OFF
135	OFF	OFF	OFF	ON	ON	ON	ON	OFF
136	ON	ON	ON	OFF	ON	ON	ON	OFF
137	OFF	ON	ON	OFF	ON	ON	ON	OFF
138	ON	OFF	ON	OFF	ON	ON	ON	OFF
139	OFF	OFF	ON	OFF	ON	ON	ON	OFF
140	ON	ON	OFF	OFF	ON	ON	ON	OFF
141	OFF	ON	OFF	OFF	ON	ON	ON	OFF
142	ON	OFF	OFF	OFF	ON	ON	ON	OFF
143	OFF	OFF	OFF	OFF	ON	ON	ON	OFF
144	ON	ON	ON	ON	OFF	ON	ON	OFF
145	OFF	ON	ON	ON	OFF	ON	ON	OFF
146	ON	OFF	ON	ON	OFF	ON	ON	OFF
147	OFF	OFF	ON	ON	OFF	ON	ON	OFF
148	ON	ON	OFF	ON	OFF	ON	ON	OFF
149	OFF	ON	OFF	ON	OFF	ON	ON	OFF
150	ON	OFF	OFF	ON	OFF	ON	ON	OFF
151	OFF	OFF	OFF	ON	OFF	ON	ON	OFF
152	ON	ON	ON	OFF	OFF	ON	ON	OFF
153	OFF	ON	ON	OFF	OFF	ON	ON	OFF
154	ON	OFF	ON	OFF	OFF	ON	ON	OFF
155	OFF	OFF	ON	OFF	OFF	ON	ON	OFF
156	ON	ON	OFF	OFF	OFF	ON	ON	OFF
157	OFF	ON	OFF	OFF	OFF	ON	ON	OFF
158	ON	OFF	OFF	OFF	OFF	ON	ON	OFF
159	OFF	OFF	OFF	OFF	OFF	ON	ON	OFF
160	ON	ON	ON	ON	ON	OFF	ON	OFF
161	OFF	ON	ON	ON	ON	OFF	ON	OFF
162	ON	OFF	ON	ON	ON	OFF	ON	OFF
163	OFF	OFF	ON	ON	ON	OFF	ON	OFF
164	ON	ON	OFF	ON	ON	OFF	ON	OFF
165	OFF	ON	OFF	ON	ON	OFF	ON	OFF
166	ON	OFF	OFF	ON	ON	OFF	ON	OFF
167	OFF	OFF	OFF	ON	ON	OFF	ON	OFF
168	ON	ON	ON	OFF	ON	OFF	ON	OFF
169	OFF	ON	ON	OFF	ON	OFF	ON	OFF
170	ON	OFF	ON	OFF	ON	OFF	ON	OFF
171	OFF	OFF	ON	OFF	ON	OFF	ON	OFF
172	ON	ON	OFF	OFF	ON	OFF	ON	OFF
173	OFF	ON	OFF	OFF	ON	OFF	ON	OFF
174	ON	OFF	OFF	OFF	ON	OFF	ON	OFF
175	OFF	OFF	OFF	OFF	ON	OFF	ON	OFF
176	ON	ON	ON	ON	OFF	OFF	ON	OFF
177	OFF	ON	ON	ON	OFF	OFF	ON	OFF
178	ON	OFF	ON	ON	OFF	OFF	ON	OFF
179	OFF	OFF	ON	ON	OFF	OFF	ON	OFF
180	ON	ON	OFF	ON	OFF	OFF	ON	OFF
181	OFF	ON	OFF	ON	OFF	OFF	ON	OFF
182	ON	OFF	OFF	ON	OFF	OFF	ON	OFF
183	OFF	OFF	OFF	ON	OFF	OFF	ON	OFF
184	ON	ON	ON	OFF	OFF	OFF	ON	OFF
185	OFF	ON	ON	OFF	OFF	OFF	ON	OFF
186	ON	OFF	ON	OFF	OFF	OFF	ON	OFF
187	OFF	OFF	ON	OFF	OFF	OFF	ON	OFF
188	ON	ON	OFF	OFF	OFF	OFF	ON	OFF
189	OFF	ON	OFF	OFF	OFF	OFF	ON	OFF
190	ON	OFF	OFF	OFF	OFF	OFF	ON	OFF
191	OFF	OFF	OFF	OFF	OFF	OFF	ON	OFF

ADDRESS	SW1	SW2	SW3	SW4	SW5	SW6	SW7	SW8
192	ON	ON	ON	ON	ON	ON	OFF	OFF
193	OFF	ON	ON	ON	ON	ON	OFF	OFF
194	ON	OFF	ON	ON	ON	ON	OFF	OFF
195	OFF	OFF	ON	ON	ON	ON	OFF	OFF
196	ON	ON	OFF	ON	ON	ON	OFF	OFF
197	OFF	ON	OFF	ON	ON	ON	OFF	OFF
198	ON	OFF	OFF	ON	ON	ON	OFF	OFF
199	OFF	OFF	OFF	ON	ON	ON	OFF	OFF
200	ON	ON	ON	OFF	ON	ON	OFF	OFF
201	OFF	ON	ON	OFF	ON	ON	OFF	OFF
202	ON	OFF	ON	OFF	ON	ON	OFF	OFF
203	OFF	OFF	ON	OFF	ON	ON	OFF	OFF
204	ON	ON	OFF	OFF	ON	ON	OFF	OFF
205	OFF	ON	OFF	OFF	ON	ON	OFF	OFF
206	ON	OFF	OFF	OFF	ON	ON	OFF	OFF
207	OFF	OFF	OFF	OFF	ON	ON	OFF	OFF
208	ON	ON	ON	ON	OFF	ON	OFF	OFF
209	OFF	ON	ON	ON	OFF	ON	OFF	OFF
210	ON	OFF	ON	ON	OFF	ON	OFF	OFF
211	OFF	OFF	ON	ON	OFF	ON	OFF	OFF
212	ON	ON	OFF	ON	OFF	ON	OFF	OFF
213	OFF	ON	OFF	ON	OFF	ON	OFF	OFF
214	ON	OFF	OFF	ON	OFF	ON	OFF	OFF
215	OFF	OFF	OFF	ON	OFF	ON	OFF	OFF
216	ON	ON	ON	OFF	OFF	ON	OFF	OFF
217	OFF	ON	ON	OFF	OFF	ON	OFF	OFF
218	ON	OFF	ON	OFF	OFF	ON	OFF	OFF
219	OFF	OFF	ON	OFF	OFF	ON	OFF	OFF
220	ON	ON	OFF	OFF	OFF	ON	OFF	OFF
221	OFF	ON	OFF	OFF	OFF	ON	OFF	OFF
222	ON	OFF	OFF	OFF	OFF	ON	OFF	OFF
223	OFF	OFF	OFF	OFF	OFF	ON	OFF	OFF
224	ON	ON	ON	ON	ON	OFF	OFF	OFF
225	OFF	ON	ON	ON	ON	OFF	OFF	OFF
226	ON	OFF	ON	ON	ON	OFF	OFF	OFF
227	OFF	OFF	ON	ON	ON	OFF	OFF	OFF
228	ON	ON	OFF	ON	ON	OFF	OFF	OFF
229	OFF	ON	OFF	ON	ON	OFF	OFF	OFF
230	ON	OFF	OFF	ON	ON	OFF	OFF	OFF
231	OFF	OFF	OFF	ON	ON	OFF	OFF	OFF
232	ON	ON	ON	OFF	ON	OFF	OFF	OFF
233	OFF	ON	ON	OFF	ON	OFF	OFF	OFF
234	ON	OFF	ON	OFF	ON	OFF	OFF	OFF
235	OFF	OFF	ON	OFF	ON	OFF	OFF	OFF
236	ON	ON	OFF	OFF	ON	OFF	OFF	OFF
237	OFF	ON	OFF	OFF	ON	OFF	OFF	OFF
238	ON	OFF	OFF	OFF	ON	OFF	OFF	OFF
239	OFF	OFF	OFF	OFF	ON	OFF	OFF	OFF
240	ON	ON	ON	ON	OFF	OFF	OFF	OFF
241	OFF	ON	ON	ON	OFF	OFF	OFF	OFF
242	ON	OFF	ON	ON	OFF	OFF	OFF	OFF
243	OFF	OFF	ON	ON	OFF	OFF	OFF	OFF
244	ON	ON	OFF	ON	OFF	OFF	OFF	OFF
245	OFF	ON	OFF	ON	OFF	OFF	OFF	OFF
246	ON	OFF	OFF	ON	OFF	OFF	OFF	OFF
247	OFF	OFF	OFF	ON	OFF	OFF	OFF	OFF
248	ON	ON	ON	OFF	OFF	OFF	OFF	OFF
249	OFF	ON	ON	OFF	OFF	OFF	OFF	OFF
250	ON	OFF	ON	OFF	OFF	OFF	OFF	OFF
251								
252								
253								
254								
255								

## Alternative Soft Addressing Option

Using our hand held MkII programmer (Part No: 48-004), the unit can be addressed electronically.

**Step 1:** Set all addresses to zero 0000000

**Step 2:** Connect leads to LOOP IN+ and LOOP IN- as shown below

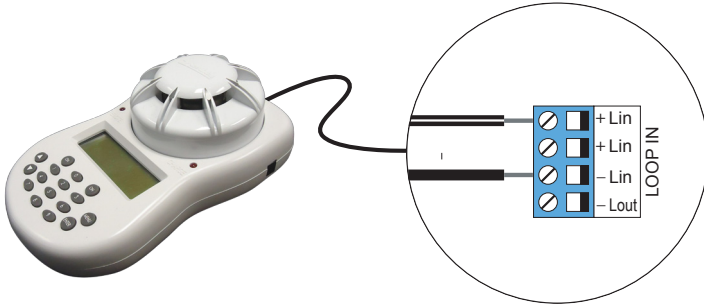

**Step 3:** Follow the procedure as described in the handheld programmer manual.

**NOTE:** When a device is soft addressed as above, the address CANNOT BE CHANGED by mechanical setting of the dip-switch. In order to re-enable the dip-switch the unit needs to be set electronically back to zero first.

## Isolator Function

The Isolator Function can be enabled or disabled according to the wiring method.

**B. Enabling the Isolator Function**

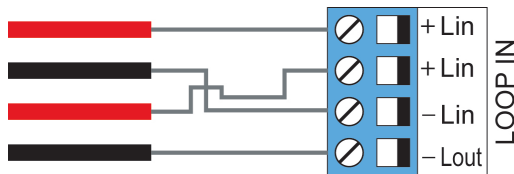

**A. By-passing the Isolator Function**

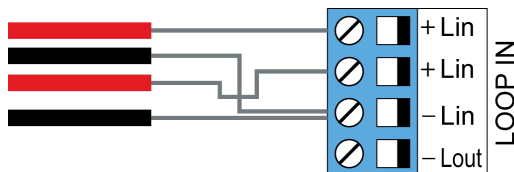

## Functional Test Data

Command Bit	Function	Input Bit	Function
3	Not Used	3	Not Used
2	ENABLE SWITCH CLOSED LED 0 = Normal 1 = Illuminated Switch Closed LED	2	Not Used
1	Not Used	1	OPTO INPUT 0 = No Input 1 = Voltage On Input
0	OPERATES RELAY 0 = Relay On 1 = Relay Off	0	MONITORED INPUT 0 = Quiescent 1 = Input Received

## Input Condition and Status

Status	Load Input	Analogue	LED State	Input Bit. Bit 0
Short-circuit fault	<100Ω	8	Fault LED	=0
Indeterminate	100Ω-200Ω	8 or 72	/	=0 or 1
Switch closed	200Ω-11kΩ	136	Switch Closed	=1
Indeterminate	11kΩ-15kΩ	136 or 72	/	=0 or 1
Normal (Switch open)	15kΩ-25kΩ	72	-	0
Indeterminate	25kΩ-30kΩ	8 or 72	/	0
Open-circuit fault	>30kΩ	8	Fault LED	0

## Analogue Return Back

Voltage Input	Analogue Value	LED State	Input Bit.Bit 1
<1V	Irrelevant	Irrelevant	=0
1V-4V	Irrelevant	Irrelevant	=0/1
4V-35V	Irrelevant	Irrelevant	=1
>35V(not allowed)	Irrelevant	Irrelevant	/

## Troubleshooting

Before investigating individual units for faults, it is very important to check that the system wiring is fault free. Many fault conditions are the result of simple wiring errors. Check all connections to the unit and make sure that the correct value resistors are fitted where necessary.

## Faultfinding

Problem	Possible Cause
No response or missing	Incorrect address setting Incorrect loop wiring
Fault condition reported	Incorrect input wiring
Relay fails to operate	Control panel has incorrect cause and effect programming Incorrect address setting
Relay energized continuously	Incorrect loop wiring Incorrect address setting
Analogue value unstable	Dual address Loop data fault, data corruption
Constant alarm	Incorrect wiring Incorrect end-of-line resistor fitted Incompatible control panel software

 0905
Zeta Alarms Limited, 72-78 Morfa Road, Swansea SA1 2EN  14  GLT-233-DoP-1
EN54-18: 2005 EN54-17: 2005  Fire detection and fire alarm systems - Input/Output Devices Fire detection and fire alarm systems - Short Circuit Isolators  Zeta Addressable Input Output Module with Isolator ZAIO-MI  Intended for use in fire detection and fire alarm systems in and around buildings  Response delay (response time) - PASS Performance under fire conditions - PASS Operational reliability - PASS Durability of operational reliability: temperature resistance - PASS Durability of operational reliability; vibration resistance - PASS Durability of operational reliability; humidity resistance - PASS Durability of operational reliability; corrosion resistance - PASS Durability of operational reliability; electrical stability - PASS