

# Graphical Alarm Manager

(QT-DL/1, QT-DL/5, QT-DL/20 & QT-DL/64)

## Description

The Quatro Addressable system has a PC graphics package called Datalog Alarm Manager. This is an advanced system, based on our software partner's many years experience in the event logging industry. The system is of a modular design, with the aim of the end user just purchasing the modules required.

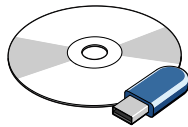

The configuration is powerful but intuitive, allowing large systems to be configured with ease. The configuration of the system is done with different software package to the normal operation software, so that an inquisitive operator has no facility to accidentally change the system. The configuration software is available as a single site licence,

allowing the user to just edit the data on a specific site, or as a multi-site licence. This is aimed at system installers who may regularly install such systems. The software will run on any Windows PC of suitable specification, allowing the user to choose their own PC hardware.

The system is available in a number of sizes, ranging from a single panel, to 32 panel network or combined networks up to 64 nodes. This allows the user to select the size that suits their system.

A separate software module (QMS) is available that allows a screen to be used as a mimic, allowing a simpler solution to the usual LED mimic often used in large buildings

Our software partners offer a 3D rendered site map service, to give the Datalog alarm manager a hugely impressive first point of contact.

## Lite (QT-DL/1)

For Connection to a Single Quatro Panel

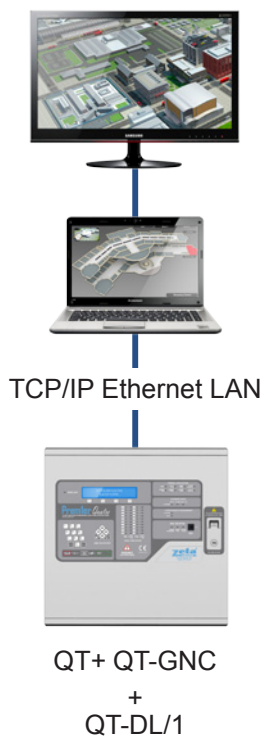



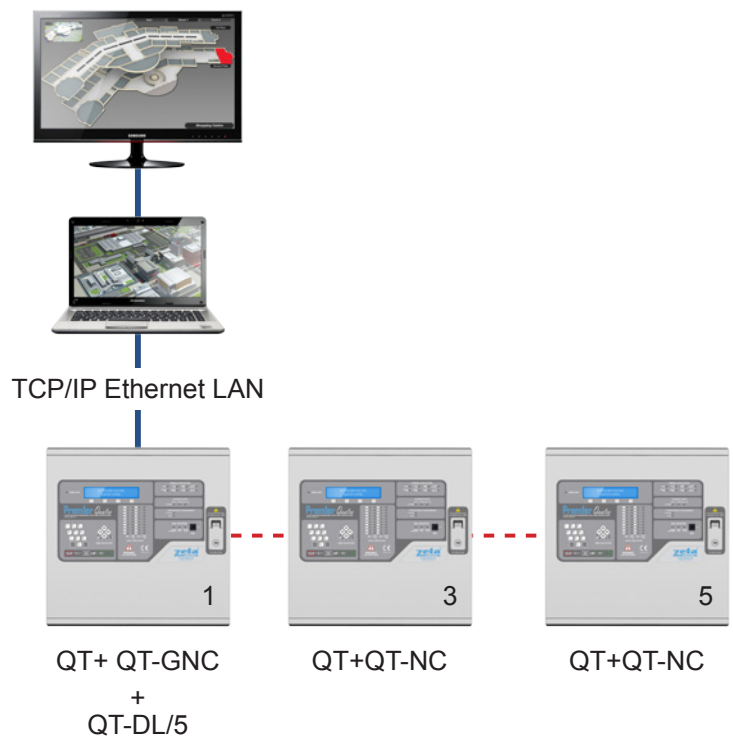

## QT-DL/5, QT-DL/20 & QT-DL/64

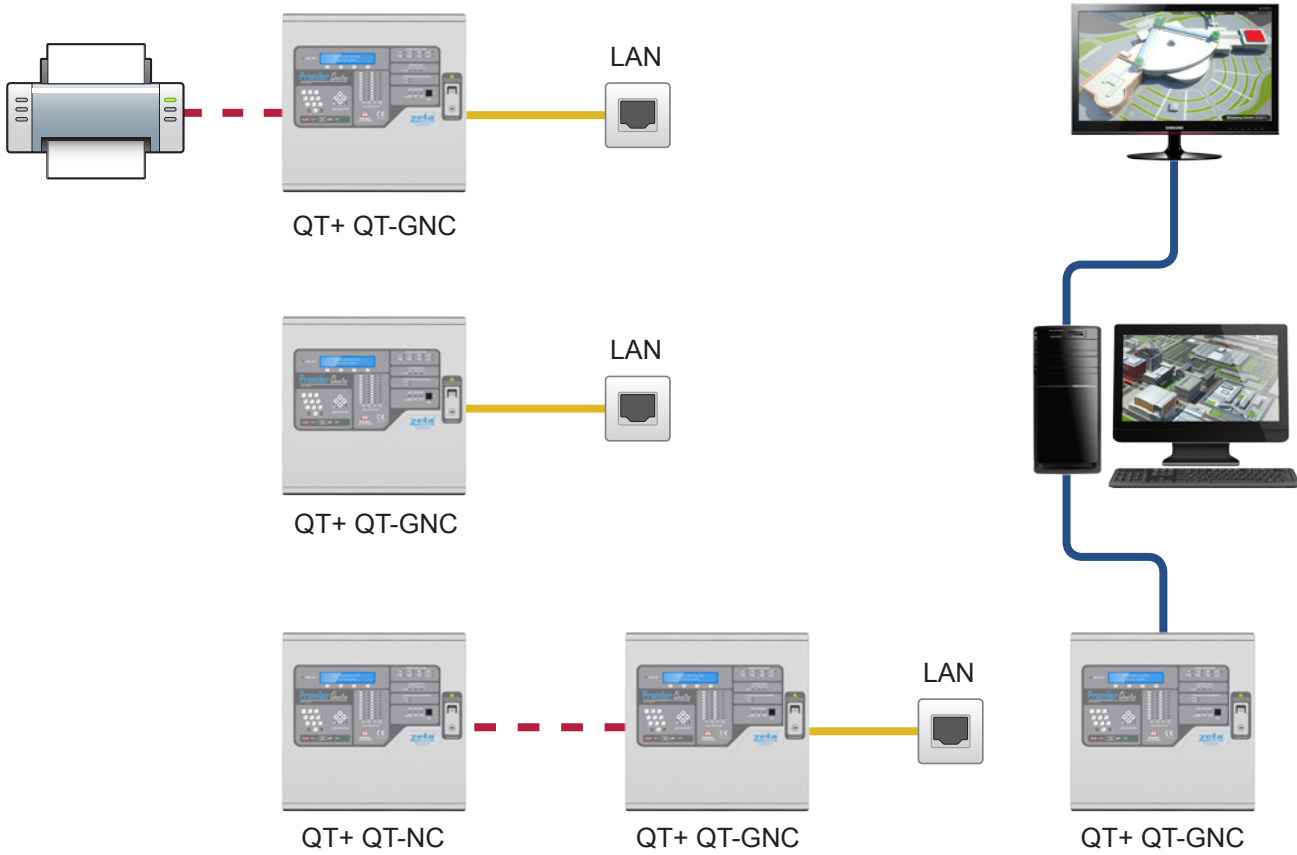
For Connection of Up to 64 Panels via a Multiple Zeta Panel Network





## Features

-  The panel network can be via hard wire or via LAN and a maximum of 5 panels (nodes) can be networked on the DL5
-  Any panel connected via LAN requires a Gateway Network Card QT-GNC
-  Any hard wired network would require a QT-NC Network Card
-  Mimic output is via video output in CPU
-  Repeater must be hardwired to any panel

## Technical Specification

Model	QT-DL/1	QT-DL/5	QT-DL/20	QT-DL/64
Part No.	37-550	37-551	37-552	37-553
Max Network Nodes	1	5	20	64
Mimic Output	1	1	1	1
Connection to Computer	Hardwire or LAN			